

Automotive Lighting Products



PROFESSIONAL LIGHTING SOLUTIONS – HIGH PERFORMANCE AND RELIABILITY

A photograph of a modern building at night. The building has a large glass facade that reflects the dark sky and some lights. On the top edge of the building, the word "demmon" is written in a glowing, blue, sans-serif font. To the left of the text is a small, stylized logo consisting of three curved lines. The sky is dark with some clouds. In the background, another building with a curved roof and a flagpole with a Turkish flag are visible.

demmon

Introduction

Driving the technology of the future today, Demmon redefines the driving experience with its innovative lighting solutions. Designed with an advanced engineering approach, our products combine maximum illumination performance with minimal energy consumption, while contributing to a sustainable future through their environmentally conscious structure.

Durability and reliability are the core foundations of Demmon. Our lighting systems are engineered to deliver superior performance even under the harshest road and weather conditions, offering long-lasting use. This approach, which prioritizes quality and efficiency in every detail, provides not just a product, but a safe and uninterrupted driving experience.

As Demmon, our goal is to bring together technology, design, and environmental responsibility in one unified vision, setting the lighting standards of the future today.

The Demmon logo, featuring a stylized icon of three curved lines to the left of the word "demmon" in a bold, sans-serif font, followed by a registered trademark symbol (®).

demmon®



LED LIGHTS

DM-9090-SXA
10" LED DRIVING LIGHT
WITH DRL & TURN SIGNAL

VOLTAGE:	9-32V
LED:	8 PCS
POWER:	90W
BEAM PATTERN:	DRIVING BEAM
POSITION LIGHT:	AMBER + WHITE
IP-CLASS:	IP67
BASE:	ALUMINUM
LENS:	POLYCARBONATE (PC)
DIMENTIONS:	244X141X98MM
OPERATING TEMPERATURE:	-40°C TO +65°C
E-APPROVED:	ECE R148 & R149 & R10
CONNECTION:	DT SOCKET

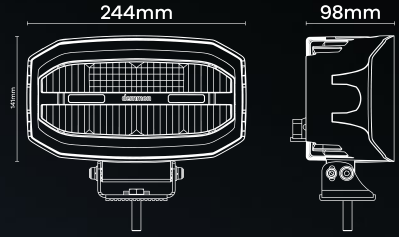

KAPAKLI TASARIM

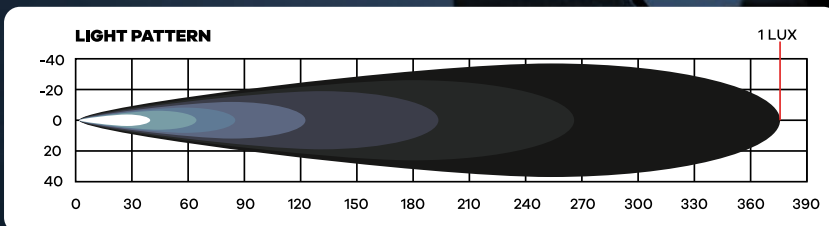

DM-6035-SXR
6" LED REVERSING LIGHT
WITH DRL & TURN SIGNAL & STOP

ECE APPROVED

25007

R1 2A S1 AR

E9

E9

10R-06

148R00-24143



VOLTAGE:	9-32V
LED:	9 PCS
POWER:	27W
BEAM PATTERN:	FLOOD BEAM
POSITION LIGHT:	AMBER + WHITE + RED
IP-CLASS:	IP67
BASE:	ALUMINUM
LENS:	POLYCARBONATE (PC)
DIMENTIONS:	120X136X43MM
OPERATING TEMPERATURE:	-40°C TO +65°C
E-APPROVED:	ECE R148 & R10
CONNECTION:	5-CORE WIRE

DM-6036-SXT
6" LED TAIL LIGHT
WITH TURN SIGNAL & STOP & BRAKE

ECE APPROVED

25007

E9

10R-06

R12A S1 AR

E9

148R00-24143



VOLTAGE:

LED:

POWER:

BEAM PATTERN:

POSITION LIGHT:

IP-CLASS:

BASE:

LENS:

DIMENTIONS:

OPERATING TEMPERATURE:

E-APPROVED:

CONNECTION:

9-32V

9 PCS

27W

FLOOD BEAM

AMBER + RED

IP67

ALUMINUM

POLYCARBONATE (PC)

120X136X43MM

-40°C TO +65°C

ECE R148 & R10

5-CORE WIRE



AMBER



RED

DM-3034-SXA
5" LED REVERSING LIGHT

VOLTAGE: 9-32V
POWER: 27W
LED: 9PCS
BEAM PATTERN: SPOT BEAM
POSITION LIGHT: WHITE
IP-CLASS: IP67
BASE: ALUMINUM
LENS: POLYCARBONATE (PC)
DIMENSIONS: 110X110X37MM
OPERATING TEMPERATURE: -40°C-+65°C
E-APPROVED: ECE R148 & R10
CONNECTION: 2-CORE WIRE

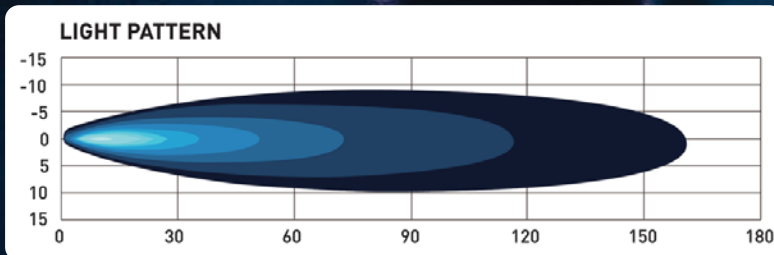
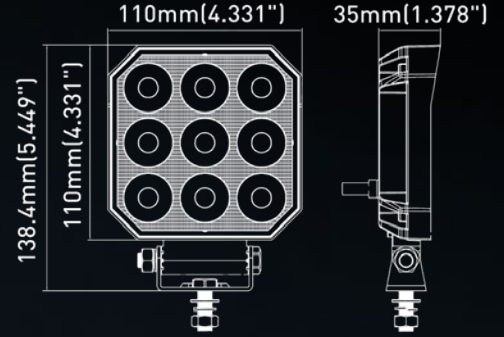

ECE APPROVED

AR 148R00 10R-06 E9 16811 23812

DM-9062-SXA

10" LED DRIVING LIGHT WITH DRL & TURN SIGNAL

VOLTAGE: 9-32V

POWER: 48W

LED: 8+24PCS

BEAM PATTERN: DRIVING BEAM

POSITION LIGHT: AMBER + WHITE

IP-CLASS: IP67

CONNECTION: 5-CORE WIRE

BASE: ALUMINUM

LENS: POLYCARBONATE (PC)

OPERATING TEMPERATURE: -40°C+65°C

DIMENSIONS: 245X139.4X90MM

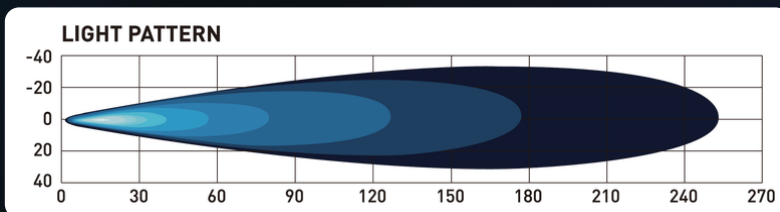
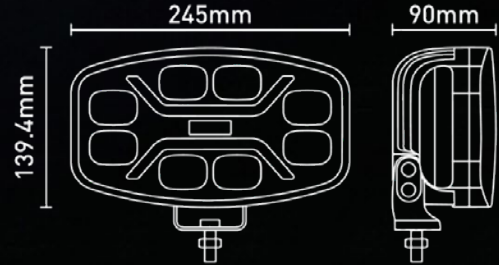

ECE APPROVED

12.5
A 148R00
HR PL 149R00
10R-06
E9 16170
23812

DM-9065-SXA

10" LED DRIVING LIGHT

WITH DRL & TURN SIGNAL



VOLTAGE: 9-32V

POWER: 57W

LED: 10+80PCS

BEAM PATTERN: DRIVING BEAM

POSITION LIGHT: AMBER + WHITE

IP-CLASS: IP67

BASE: ALUMINUM

LENS: POLYCARBONATE (PC)

DIMENSIONS: 245X139.4X90MM

OPERATING TEMPERATURE: -40°C-+60°C

E-APPROVED: ECE R148 & R149 & R10

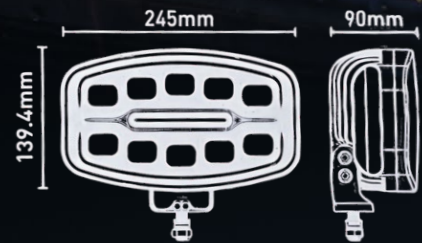

ECE APPROVED

12.5
A 148R00
HR PL 149R00
10R-06

E9

16170
23812

DM-5038-SXR

5" LED REVERSING LIGHT
WITH STOP LIGHT & TURN SIGNAL



DM-9065-SXF

10" LED DRIVING LIGHT
WITH DRL TURN SIGNAL & FLASH

DM-9066-SXF

10" LED DRIVING LIGHT
WITH DRL TURN SIGNAL & FLASH



DM-9070-RXA

9" LED DRIVING LIGHT WITH DRL & TURN SIGNAL

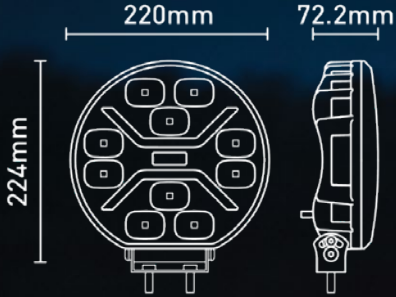

VOLTAGE: 9-32V

POWER: 70W

LED: 10+24PCS

BEAM PATTERN: DRIVING BEAM

POSITION LIGHT: AMBER + WHITE

IP-CLASS: IP67

BASE: ALUMINUM

LENS: POLYCARBONATE (PC)

DIMENSIONS: 220X224X72.2MM

OPERATING TEMPERATURE: -40°C-+65°C

E-APPROVED: ECE R148 & R149 & R10

CONNECTION: 5-CORE WIRE

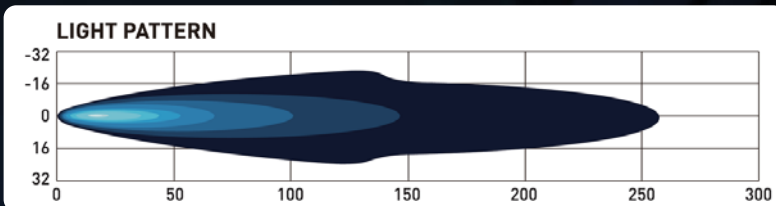

ECE APPROVED

12.5
A 148R00
HR PL 149R00
10R-06

E9

11492
23640

DM-7090-RXA
7" LED DRIVING LIGHT
WITH DRL & TURN SIGNAL

VOLTAGE:	9-36V
LED:	14 PCS
POWER:	65W
BEAM PATTERN:	DRIVING BEAM
POSITION LIGHT:	AMBER + WHITE
IP-CLASS:	IP67
BASE:	ALUMINUM
LENS:	POLYCARBONATE (PC)
DIMENSIONS:	189X184X57MM
OPERATING TEMPERATURE:	-40°C TO +65°C
E-APPROVED:	ECE R148 & R149 & R10
CONNECTION:	4-CORE WIRE

ECE APPROVED

A 148R00 (E9) 10 23166
HR PL 149R00

10R-05 (E9) 10 23166



DM-17080-SXA
17" TRUCK DRIVING BAR
WITH DRL TURN SIGNAL & FLASH

VOLTAGE:	9-32V
LED:	8PCS
POWER:	80W
BEAM PATTERN:	DRIVING BEAM
POSITION LIGHT:	AMBER + WHITE
IP-CLASS:	IP67
BASE:	ALUMINUM
LENS:	POLYCARBONATE (PC)
DIMENTIONS:	473X98X96MM
OPERATING TEMPERATURE:	-40°C TO +65°C
E-APPROVED:	ECE R65 & R148 & R149 & R10
CONNECTION:	6-CORE WIRE

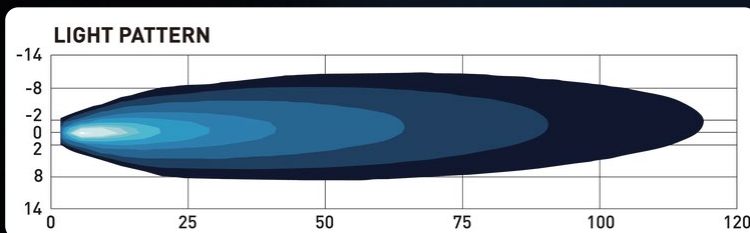

ECE APPROVED

XA1 00 20
A 148R00
HR PL 149R00
10R-06

E9

16936
23812

DM-9066-SXA
10" LED DRIVING LIGHT
WITH DRL & TURN SIGNAL



DM-800214
LED TAIL LIGHT
WITH TURN SIGNAL

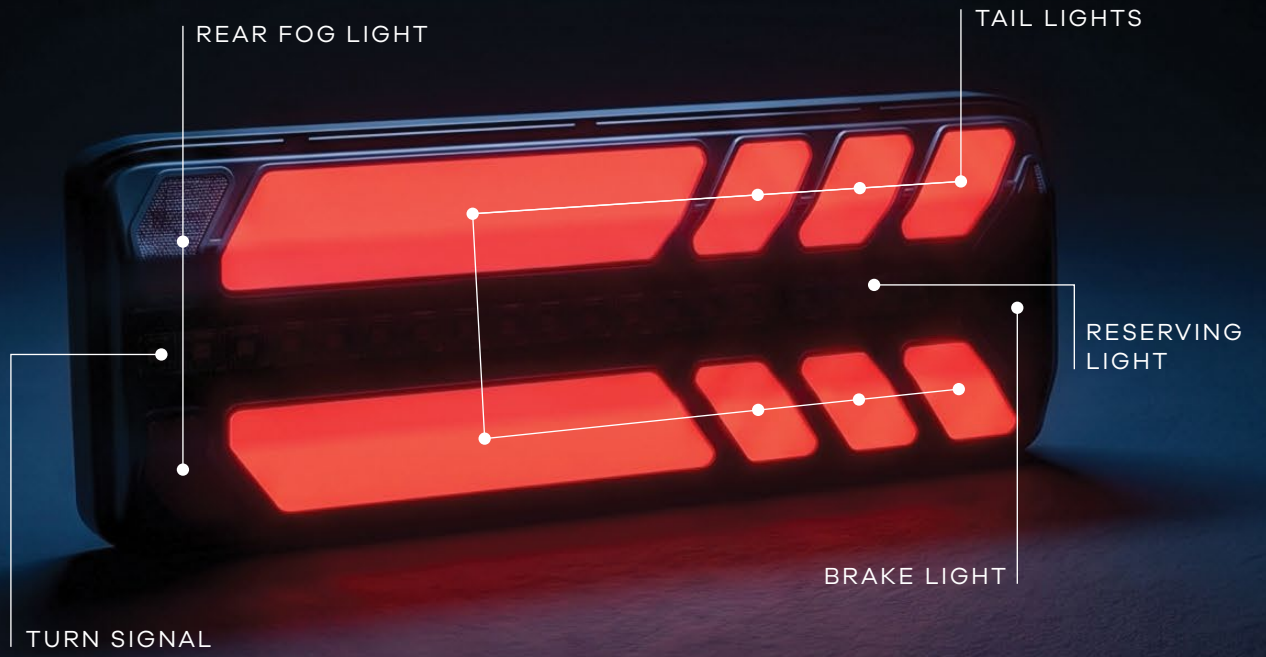

A person wearing a dark jacket and a glove is holding a glowing yellow LED warning light. The light is cylindrical with a textured, grid-like surface and is emitting a bright yellow glow. The background is dark with some blurred lights, suggesting an outdoor setting at night.

**LED
WARNING LIGHTS**

DM-910B
LED WARNING LIGHT
WITH MAGNET & CAR CHARGER PLUG

VOLTAGE: 9-30V
POWER: 42W
LED: 42 PCS
PATTERNS: 10 PATTERNS
IP-CLASS: IP67
CONNECTION: CIGAR PLUG
BASE: ALUMINUM
LENS: POLYCARBONATE (PC)
DIMENSIONS: 142X142X77.5MM
E-APPROVED: ECE R65 & R10



ECE APPROVED

TA1 **E9** 00 6653

E9 10R-05 16661

DM-910A
LED WARNING LIGHT
WITH FLEXIBLE DIN MOUNT



ECE APPROVED

TA1 (E9) 00 6653

(E9) 10R-05 16661

VOLTAGE: 9-30V
POWER: 42W
LED: 42 PCS
PATTERNS: 10 PATTERNS
IP-CLASS: IP67
CONNECTION: FLEXIBLE DIN MOUNT
BASE: ALUMINUM
LENS: POLYCARBONATE (PC)
DIMENSIONS: 117X117X173MM
E-APPROVED: ECE R65 & R10

LED WARNING LIGHTS



DM-891AG



DM-891AR



DM-891AY



DM-889BY



DM-900A



DM-900B

DM-891AG | DM-891AR | DM-891AY
LED WARNING LIGHTS

R65
CLASS 1

R10
ECE



VARIOUS COLORS ARE AVAILABLE



WHITE



RED



AMBER

Flash Patterns

- . Single Flash (ECE R65)
- . Double Flash (ECE R65)
- . Quad Flash (ECE R65)
- . Octa Flash
- . Single Flash - Slow
- . Single Flash (Breath-like)
- . Rotating Flash

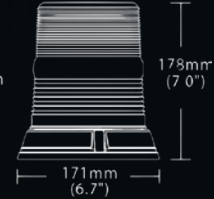

VOLTAGE:

DC 12-24V

LED QUANTITY:

48 PCS (LOW PROFILE)
60 PCS (HIGH PROFILE)

LED:

42 PCS

IP RATING:

IP67

OPERATING TEMPERATURE:

-30°C TO +60°C

CERTIFICATIONS:

UKCA, CE, ECE R10, ECE R65, SAE J845 CLASS 1,
CISPR 25 CLASS 3

LENS OPTIONS:

AMBER / CLEAR / DARK TINTED



TRUCK LIGHTING

MERCEDES | MAN | SCANIA | VOLVO |
RENAULT | FORD | DAF | IVECO



MERCEDES
HEADLIGHTS | TAIL LIGHTS

HEADLIGHTS

MERCEDES



DM-100124



DM-100125



DM-100168



DM-100169

ACTROS MP3

AXOR II MANUAL



DM-100202



DM-100203



DM-100206



DM-100207

AROCS

AROCS GEN-2



DM-100210



DM-100211

AROCS GEN - 3

HEADLIGHTS

MERCEDES



DM-100214



DM-100215

ACTROS MP4



DM-100222



DM-100223

ACTROS MP5 GEN-1



DM-100226



DM-100227

ACTROS MP5 GEN-1 XENON



DM-100230



DM-100231

ACTROS MP5 GEN-2



DM-100234



DM-100235

ACTROS MP5 GEN-2



DM-100238



DM-100239

ACTROS MP5 GEN-3

TAIL LIGHTS

MERCEDES



DM-100142



DM-100143



DM-100144



DM-100145

ACTROS HALOGEN TAIL LIGHT

**ACTROS HALOGEN TAIL LIGHT WITH
REVERSE WARNING BUZZER**



DM-100178



DM-100179

AXOR - ACTROS HALOGEN TAIL LIGHT



DM-100250



DM-100251

ACTROS LED TAIL LIGHT



DM-100252



DM-100253

**ACTROS LED TAIL LIGHT WITH
REVERSE WARNING BUZZER**



MAN

HEADLIGHTS | TAIL LIGHTS

HEADLIGHTS

MAN



DM-200118



DM-200119



DM-200142



DM-200143

TGA MANUAL

TGX MANUAL HEADLIGHT



DM-200156



DM-200157

TGX - TGS MANUAL

TAIL LIGHTS

MAN



DM-200134



DM-200135

TGA-TGX HALOGEN TAIL LIGHT



DM-200168



DM-200169

TGX - TGS LED TAIL LIGHT



SCANIA

HEADLIGHTS | TAIL LIGHTS

HEADLIGHTS

SCANIA



DM-300150



DM-300151



DM-300154



DM-300155

P-G-R-T MANUAL TURN SIGNAL

**P-G-R-T STREAMLINE
INDICATOR LAMP**



DM-300190



DM-300191



DM-300194



DM-300195

P-G MANUAL

NGS MANUAL

TAIL LIGHTS

SCANIA



DM-300174



DM-300175

P-G-R HALOJEN TAIL LIGHT



DM-300214



DM-300215

NGS - NGT LED TAIL LIGHT



DM-300222



DM-300223

NGS - NGT GEN-2 LED TAIL LIGHT

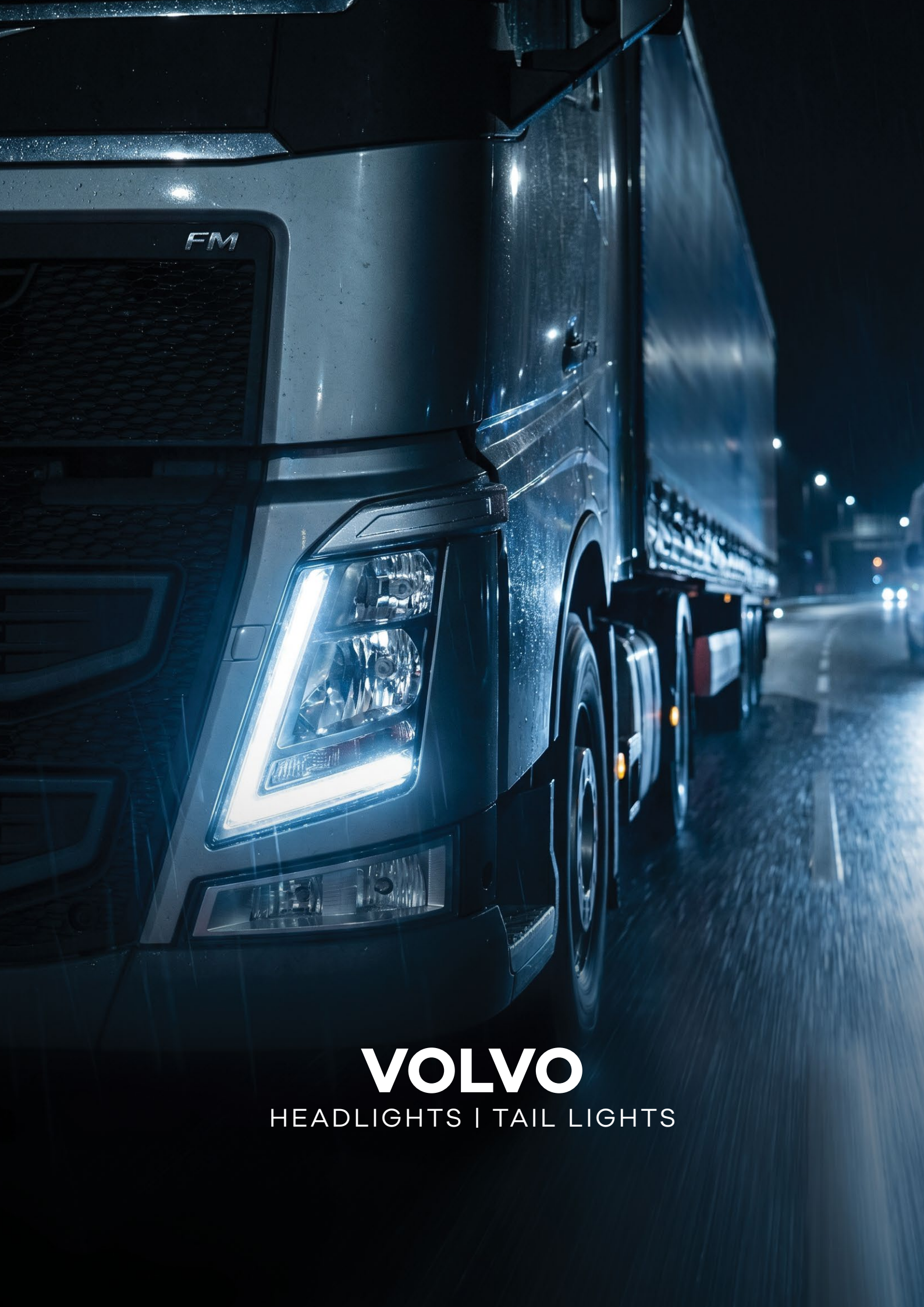

FM

VOLVO

HEADLIGHTS | TAIL LIGHTS

HEADLIGHTS VOLVO



DM-400144



DM-400145

FH - FM VERSION 3 MANUAL



DM-400188



DM-400189

FH4 MANUAL CHROME



DM-400204



DM-400205

FMX MANUAL



DM-400221



DM-400222

FH5 MANUAL LED CHROME

TAIL LIGHTS VOLVO



DM-400134



DM-400135

FH-FM HALOGEN TAIL LIGHT



DM-400260



DM-400261

FH-FM LED TAIL LIGHT



RENAULT
HEADLIGHTS

HEADLIGHTS

RENAULT



DM-500144



DM-500145



DM-500160



DM-500161

PREMIUM II MANUAL CHROME

T SERIES MANUAL



DM-500164



DM-500165



DM-500168



DM-500169

T SERIES GEN-2 MANUAL

K SERIES MANUAL



 demmon[®]





FORD
HEADLIGHTS

HEADLIGHTS

FORD



DM-800106



DM-800107

F-MAX ELECTRIC CHROME



DAF
HEADLIGHTS

HEADLIGHTS

DAF



DM-600104



DM-600105

XF105 MANUAL



DM-600150



DM-600151

XF106 MANUAL



DM-600154



DM-600155

XF106 LED



IVECO

HEADLIGHTS | TAIL LIGHTS

HEADLIGHTS

IVECO



DM-700148



DM-700149

STRALIS XENON

TAIL LIGHTS

IVECO



DM-700196



DM-700197

S-WAY LED TAIL LIGHT



Akşemseddin Mah, 265/1 Sk
No:23, 34510 Esenyurt/İstanbul

+90(212) 864 39 03

info@demmon.com.tr

demmontr